

# MEITRACK MVT600 User Guide



## Change History

File Name	MEITRACK MVT600 User Guide	Created By	Kyle Lv
Project	MVT600	Creation Date	2010-08-30
		Update Date	2017-03-24
Subproject	User Guide	Total Pages	17
Version	V3.5	Confidential	External Documentation

## Contents

1 Copyright and Disclaimer.....	- 4 -
2 Product Overview.....	- 4 -
3 Product Functions and Specifications.....	- 4 -
3.1 Product Functions.....	- 4 -
3.1.1 Position Tracking.....	- 4 -
3.1.2 Anti-Theft.....	- 4 -
3.1.3 Functions of Optional Accessories.....	- 5 -
3.1.4 Other Functions.....	- 5 -
3.2 Specifications.....	- 5 -
4 MVT600 and Accessories.....	- 6 -
5 Appearance.....	- 7 -
6 First Use.....	- 7 -
6.1 Installing the SIM Card.....	- 7 -
6.2 Charging the Device.....	- 8 -
6.3 LED Indicator.....	- 8 -
6.4 Configuring Device Parameters by Meitrack Manager.....	- 8 -
6.5 Tracking by Mobile Phone.....	- 9 -
6.6 Common SMS Commands.....	- 10 -
6.6.1 Setting Authorized Phone Numbers – A71.....	- 10 -
6.6.2 Setting the Smart Sleep Mode – A73.....	- 10 -
7 Logging In to MS03 Tracking System.....	- 11 -
8 Installing the MVT600.....	- 11 -
8.1 Installing GPS and GSM Antennas.....	- 11 -
8.2 Installing an I/O Cable.....	- 12 -
8.3 Wiring Diagram.....	- 13 -
8.3.1 Power Cable/Ground Wire (Pin 1/2).....	- 13 -
8.3.2 Checking Vehicle Door Status and Trunk Status (Pin 4/5, Negative Trigger).....	- 13 -
8.3.3 Checking Engine Status (Pin 3, Positive Trigger).....	- 14 -
8.3.4 Fuel/Power Cut-off (Pin 7/9/11).....	- 14 -
8.3.5 Sensor Input (Pin 8/10/12).....	- 14 -
8.3.6 Installing the Handset (RS232 Port).....	- 14 -
8.3.7 Installing a Camera (RS232 Port).....	- 15 -
8.3.8 Installing the Micro SD Card.....	- 16 -
8.3.9 Installing the RFID Reader (Start the Engine).....	- 16 -
8.4 Mounting the MVT600.....	- 16 -

## 1 Copyright and Disclaimer

Copyright © 2017 MEITRACK. All rights reserved.

 and  are trademarks that belong to Meitrack Group.

The user manual may be changed without notice.

Without prior written consent of Meitrack Group, this user manual, or any part thereof, may not be reproduced for any purpose whatsoever, or transmitted in any form, either electronically or mechanically, including photocopying and recording.

Meitrack Group shall not be liable for direct, indirect, special, incidental, or consequential damages (including but not limited to economic losses, personal injuries, and loss of assets and property) caused by the use, inability, or illegality to use the product or documentation.

## 2 Product Overview

The MVT600 is a high-end GPS vehicle tracker supporting GPS, GSM, and GPRS functions. It can connect to a variety of peripherals, such as the camera, handset, LCD display, LED display, and RFID reader. This ensures high expansion.

The MVT600 is specialized in tracking, monitoring, and protection of commercial vehicles in the delivery, logistics, taxi, and bus industries.

## 3 Product Functions and Specifications

### 3.1 Product Functions

#### 3.1.1 Position Tracking

- GPS + GSM positioning
- Real-time location query
- Track by time interval
- Track by distance
- Track by mobile phone
- Speeding alarm
- Cornering report

#### 3.1.2 Anti-Theft

- SOS alarm
- GPS antenna cut-off alarm
- External power supply cut-off alarm
- GPS blind spot alarm
- Low power alarm
- Remote vehicle fuel/power cut-off
- Towing alarm
- Engine or vehicle door status alarm
- Geo-fence

### 3.1.3 Functions of Optional Accessories

Accessory	Function
iButton	Identify the driver ID and grant permission to start the vehicle.
A53 resistive fuel level sensor	Detect an alarm when the fuel level is too high or low.
A52 digital temperature sensor + A61 sensor box	Detect an alarm when the temperature is too high or low.
A21 LCD display	Information dispatching
Handset	Listen-in or two-way calling
Camera	Take photos.
RFID reader	Swipe the RFID card to start the engine.
LED display	Display advertisements.
Speaker and microphone	Listen-in or two-way calling

### 3.1.4 Other Functions

- SMS/GPRS (TCP/UDP) communication (Meitrack protocol)
- Built-in 8 MB buffer for recording driving routes
- Internal backup battery
- Mileage report
- Over-the-Air (OTA) update
- Smart power-saving mode

### 3.2 Specifications

Item	Specifications
Dimension	103 mm x 98 mm x 32 mm
Weight	220g
Power supply	DC 11–36 V/1.5 A
Backup battery	400 mAh/3.7 V
Power consumption	Current in standby mode: 65 mA
Operating temperature	-20°C to 55°C
Operating humidity	5% to 95%
Working hour	61 hours in power-saving mode 5.7 hours in normal mode
LED indicator	2 indicators showing GSM and GPS status
Button/Switch	1 SOS button (for sending SMSs or dialing) 1 power button
Memory	8 MB buffer
Sensor	3-axis accelerometer (used to wake the device up by vibration and detect towing alarms)
GSM frequency band	GSM 850/900/1800/1900 MHz
GPS sensitivity	-161 dB
Positioning accuracy	10m

I/O port	3 inputs (2 negative inputs and 1 positive input) 1 analog detection input 1 fuel level sensor detection input 1 digital temperature sensor detection input 3 outputs 4 RS232 ports 1 Wiegand port
----------	--

### 4 MVT600 and Accessories

MVT600 and standard accessories:



MVT600 with a built-in battery



GPS antenna



GSM antenna



I/O cable + SOS button



USB cable



CD download card

Optional accessories:



Camera (at most 2 cameras)



Handset



RFID reader



A21 LCD display (dialing and SMS display)



A53 fuel level sensor



A52 digital temperature sensor + A61 sensor box (at most 8 temperature sensors)



LED display



iButton

## 5 Appearance

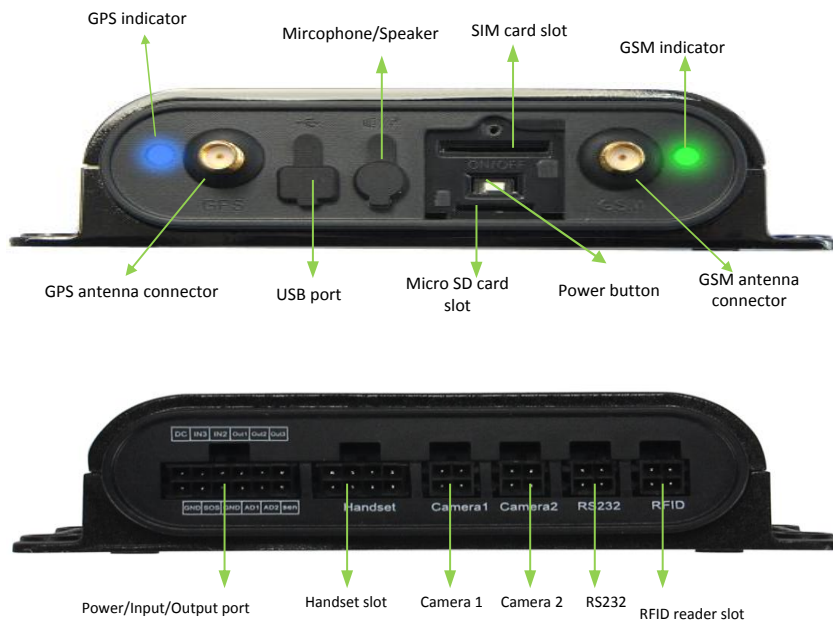

## 6 First Use

### 6.1 Installing the SIM Card

1. Loosen the screws, and remove the cover.
2. Insert the SIM card into the card slot with its gold-plated contacts facing towards the Printed Circuit Board (PCB).
3. (Optional) Insert the Micro SD card if a camera is used.
4. Close the cover, and tighten the screws.

Note:

- Power off the device before installing the SIM card.
- Ensure that the SIM card has sufficient balance.
- Ensure that the phone card PIN lock has been closed properly.
- Ensure that the SIM card in the device has subscribed the caller ID service if you want to use your authorized phone number to dial the device.



## 6.2 Charging the Device

When you use the device for the first time, connect the device's GND (-Black) and Power (+Red) wires to 12 V or 24 V external power supply for charging. Ensure that the device is charged at least three hours. Eight hours are recommended.

The device can be installed on a vehicle only after it is configured and tested.

## 6.3 LED Indicator

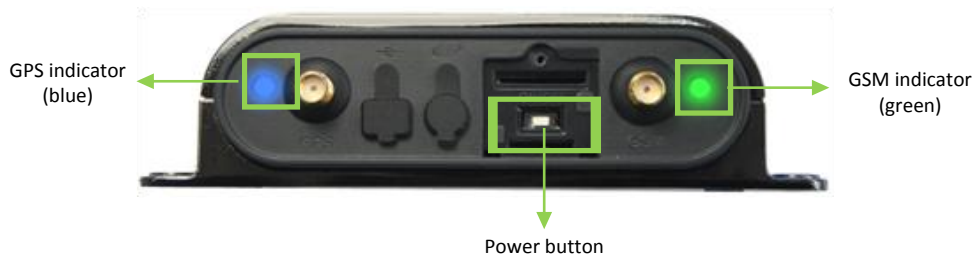

To start the device, press and hold down the power button for 3–5 seconds, or connect the device to external power supply (11–36 V).

GPS Indicator (Blue)	
Steady on	A button or an input is triggered.
Blink (every 0.1 seconds)	The device is being initialized or the battery power is low.
Blink (0.1 seconds on and 2.9 seconds off)	A GPS signal is received.
Blink (1 second on and 2 seconds off)	No GPS signal is received.
GSM Indicator (Green)	
Steady on	A call is coming in or a call is being made.
Blink (every 0.1 seconds)	The device is being initialized.
Blink (0.1 seconds on and 2.9 seconds off)	A GSM signal is received.
Blink (1 second on and 2 seconds off)	No GSM signal is received.

## 6.4 Configuring Device Parameters by Meitrack Manager

This section describes how to use Meitrack Manager to configure the device on a computer.

Procedure:

1. Install the USB-to-serial cable driver and Meitrack Manager.
2. Connect the device to a computer by using the USB-to-serial cable.



3. Run Meitrack Manager, then the following dialog box will appear:





Turn on the device, then Meitrack Manager will detect the device model automatically and the parameter page will appear accordingly.

For details about Meitrack Manager, see the *MEITRACK Manager User Guide*.

### 6.5 Tracking by Mobile Phone

Call or send the **0000,A00** command by SMS to the device's SIM card number. The device will reply to an SMS with a map link. Click the SMS link. The device's location will be displayed on Google Maps on your mobile phone.

Note: Ensure that the device's SIM card number has subscribed the caller ID service. Otherwise, the tracking function by mobile phone will be unavailable.



SMS example:

Now,061314 10:36,V,26,0Km/h,96%,http://maps.meigps.com/?lat=22.513781&lng=114.057183

The following table describes the SMS format:

Parameter	Description	Remarks
Now	Indicates the current location.	SMS header: indicates the current location or the alarm type.
061314 10:36	Indicates the date and time in <b>MMDDYY hh:mm</b> format.	None
V	The GPS is invalid.	A = Valid V = Invalid
26	Indicates the GSM signal strength.	Value: 1–32 The larger the value is, the stronger the

		signal is. If the value is greater than 12, GPRS reaches the normal level.
0Km/h	Indicates the speed.	Unit: km/h
96%	Indicates the remaining battery power.	None
<a href="http://maps.meigps.com/?lat=22.513781&amp;lng=114.057183">http://maps.meigps.com/?lat=22.513781&amp;lng=114.057183</a>	Indicates the map link. Latitude: 22.513781 Longitude: 114.057183	None

If your mobile phone does not support HTTP, enter the latitude and longitude on Google Maps to query a location.



## 6.6 Common SMS Commands

### 6.6.1 Setting Authorized Phone Numbers – A71

SMS sending: 0000,A71,Phone number 1,Phone number 2,Phone number 3

SMS reply: IMEI,A71,OK

Description:

Phone number: A phone number has a maximum of 16 bytes. If no phone numbers are set, leave them blank. Phone numbers are empty by default.

Phone number 1/2/3: SOS phone numbers. When you call the tracker by using these phone numbers, you will receive SMS notification about the location, geo-fence alarm and low power alarm.

If you need to delete all authorized phone numbers, send **0000,A71**.

When the SOS button is pressed, the tracker dials phone numbers 1, 2, and 3 in sequence. The tracker stops dialing when a phone number responds.

Example:

Sending: 0000,A71,13811111111,13822222222,13833333333

Reply: 353358017784062,A71,OK

### 6.6.2 Setting the Smart Sleep Mode – A73

SMS sending: 0000,A73,Sleep level

SMS reply: IMEI,A73,OK

Description:

When the sleep level is **0** (default value), disable the sleep mode.

When the sleep level is **1**, the tracker enters the normal sleep mode. The GSM module always works, and the GPS module occasionally enters the sleep mode. The tracker works 25% longer in the normal sleep mode than that in the normal working mode. This mode is not recommended for short interval tracking; this will affect the route precision.

When the sleep level is **2**, the tracker enters deep sleep mode. If no event (SOS, button changes, incoming calls, SMSs, or vibration) is triggered after five minutes, the GPS module will stop, and the GSM module will enter sleep mode. Once an event is triggered, the GPS and GSM modules will be woken up.

Note: In any condition, you can use an SMS command to disable the sleep mode, and then the tracker exits the sleep mode and returns back to the normal working mode.

Example:

Sending: 0000,A73,2

Reply: 353358017784062,A73,OK

**For details about SMS commands, see the *MEITRACK SMS Protocol*.**

Note:

1. The default SMS command password is **0000**. You can change the password by using Meitrack Manager and SMS command.
2. The device can be configured by SMS commands with a correct password. After an authorized phone number is set, only the authorized phone number can receive the preset SMS event report.

## 7 Logging In to MS03 Tracking System

Visit <http://ms03.trackingmate.com>, enter the user name and password, and log in to the MS03. (Purchase the login account from your provider.)

For more information about how to add a tracker, see the *MEITRACK GPS Tracking System MS03 User Guide* (chapter 4 "Getting Started").

**The MS03 supports the following functions:**

- Track by time interval or distance.
- Query historical trips.
- Set polygonal geo-fences.
- Bind driver and vehicle information.
- View various reports.
- Send commands in batches.
- Support OTA updates.

For details, see the *MEITRACK GPS Tracking System MS03 User Guide*.

## 8 Installing the MVT600

### 8.1 Installing GPS and GSM Antennas



Connect the GSM antenna to the connector which is labeled "GSM". The GSM antenna is non-directional, so you can hide it in

any place of a vehicle.

Connect the GPS antenna to the connector which is labeled "GPS". It is recommended that the antenna is facing up to the sky and the antenna side with words is downwards. Secure the antenna by using double sided tapes.

Note: Do not install the GPS antenna at a metal covered place.

## 8.2 Installing an I/O Cable

The I/O cable is a 12-pin cable, including the power, analog input, digital temperature sensor input, and negative/positive input and output interfaces.



1	3	5	7	9	11
Power (+)	Input 3 (+)	Input 2(-)	Output 1	Output 2	Output 3
2	4	6	8	10	12
GND (-)	Input 1 (-)	GND (-)	AD Input 1	Fuel level sensor	Digital temperature sensor

Pin Number	Color	Description
1 (Power +)	Red	Positive charge of the power input, connected to the positive charge of the vehicle battery. Input voltage: 11–36 V. 12 V is recommended.
2 (GND)	Black	Ground wire, connected to the negative charge of the vehicle battery or to the negative terminal.
3 (Input3)	White	Digital input 3, positive trigger Detect the vehicle ACC status. Connect to a door trigger signal cable to detect vehicle door status. (Most Europe and American cars are positive edge-triggered.)
4 (Input 1)	White	Digital input 1, negative trigger (SOS button by default)
5 (Input 2)	White	Digital input 2 (negative trigger) Connect to a door trigger signal cable to detect vehicle door status. (Most Chinese, Korean, and Japanese cars are negative edge-triggered.)
6 (GND)	Black	Ground wire It can be used as a ground wire connected to an analog sensor.
7 (Output 1)	Yellow	Output 1 Valid: low level (0 V) Invalid: open drain Maximum voltage for output open drain (invalid): 45 V Maximum current for output low voltage: 500 mA Connect to an external relay to remotely cut off the vehicle fuel cable or engine power supply.
8 (AD Input 1)	Blue	Analog input 1 with 12-bit resolution and valid voltage 0–6 V

		Connect to an external sensor, such as the fuel level sensor.
9 (Output2)	Yellow	Output 2 Valid: low level (0 V) Invalid: open drain Maximum voltage for output open drain (invalid): 45 V Maximum current for output low voltage: 500 mA Connect to an external relay to remotely cut off the vehicle fuel cable or engine power supply.
10 (Fuel level sensor input)	Blue	Analog input 2 with 12-bit resolution and valid voltage 0–6.6V The AD cable is equipped with a white plug. It is connected to the A53 fuel level sensor by default.
11 (Output 3)	Yellow	Output 3 Valid: low level (0 V) Invalid: open drain Maximum voltage for output open drain (invalid): 45 V Maximum current for output low voltage: 500 mA Connect to an external relay to remotely cut off the vehicle fuel cable or engine power supply.
12 (Digital temperature sensor or iButton input port)	Blue	TTL3.3V level Connect to the A52 digital temperature sensor or iButton by default by using the A61 sensor box. Note: The DC or AC voltage that is greater than 3.3 V is not allowed. Otherwise, the device may be damaged.

### 8.3 Wiring Diagram

#### 8.3.1 Power Cable/Ground Wire (Pin 1/2)

Connect the power cable (red) and ground wire (black) to the positive and negative charges of the vehicle battery respectively.

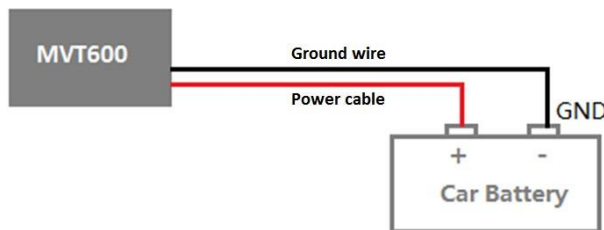

#### 8.3.2 Checking Vehicle Door Status and Trunk Status (Pin 4/5, Negative Trigger)

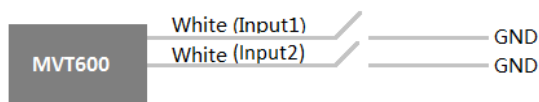

### 8.3.3 Checking Engine Status (Pin 3, Positive Trigger)

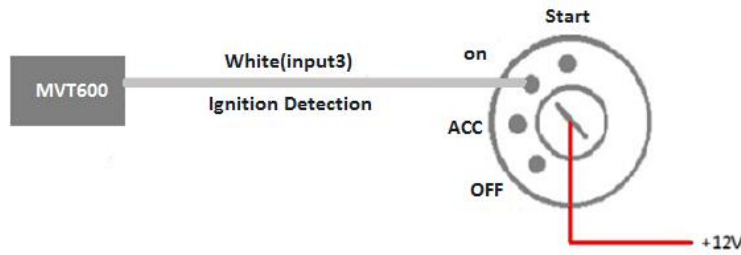

### 8.3.4 Fuel/Power Cut-off (Pin 7/9/11)

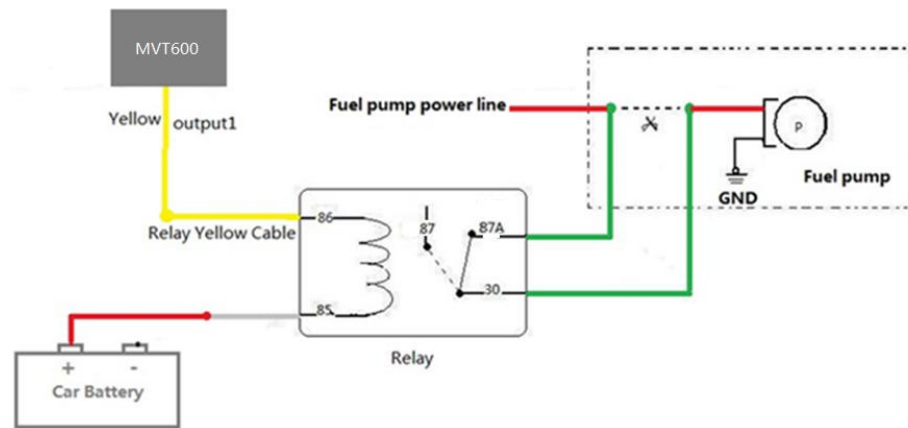

### 8.3.5 Sensor Input (Pin 8/10/12)

For pin 8 analog input 1, a sensor whose output voltage ranges from 0 V to 6.6 V can be installed. The analog voltage calculation formula is as follows:

$$\text{Voltage} = (\text{AD } 1 \times 3.3 \times 2) / 4096$$

Pin 10 is connected to the A53 fuel level sensor by default. You can install the sensor without calculation formula added on the platform. For details, see the *MEITRACK Fuel Level Sensor User Guide*.

Pin 12 is connected to A61+A52 temperature sensor or iButton by default. For details, see the *MEITRACK Temperature Sensor User Guide* and *MEITRACK iButton User Guide*.

### 8.3.6 Installing the Handset (RS232 Port)

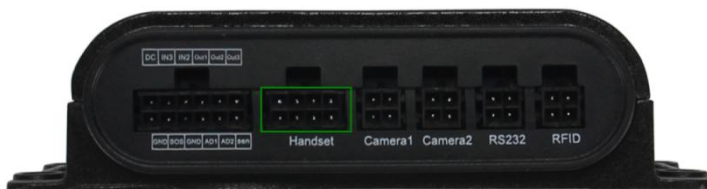

Pin Number	Color	Description
1	Red	Power output Output voltage: 5 V
2	Black	Ground wire

3	Orange	RX, MVT600 receives data from the handset.
4	Yellow	TX, MVT600 sends data to the handset.
5	Blue	Positive charge of the microphone
6	Green	Negative charge of the microphone
7	Purple	Positive charge of the speaker
8	White	Negative charge of the speaker

Note: The RS232 port supports peripherals, such as the A21 LCD display and LED display. For details about peripheral functions, see the *MEITRACK LCD Display User Guide* or *MEITRACK LED Display User Guide*.

### 8.3.7 Installing a Camera (RS232 Port)



Camera 1 RS232 Port		
Pin Number	Color	Description
1	Red	Power output Output voltage: 5 V
2	Black	Ground wire
3	Yellow	RX, MVT600 receives data from the camera.
4	Green	TX, MVT600 sends data to the camera.

Camera 2 RS232 Port		
Pin Number	Color	Description
1	Red	Power output Output voltage: 5 V
2	Black	Ground wire
3	Yellow	RX, MVT600 receives data from the camera.
4	Green	TX, MVT600 sends data to the camera.

Camera 3 RS232 Port or GPS Data Port		
Pin Number	Color	Description
1	Red	Power output Output voltage: 5 V
2	Black	Ground wire
3	Yellow	RX, MVT600 receives data from the camera.
4	Green	TX, MVT600 sends data to the camera.

Note: A Micro SD card is required if you have installed a camera. Otherwise, you cannot take photos. For details about how to install and use the camera, see the *Meitrack Camera User Guide*.

### 8.3.8 Installing the Micro SD Card

If you want to use the camera option, a Micro SD card is required. Whenever a phone is taken, it will be stored in the Micro SD card and will be uploaded to the server immediately. To retrieve an existing phone, a request must be mad from the server through GPRS command.

Insert the card into the Micro SD card slot under the power button. Ensure that its gold-plated contacts are facing up.



### 8.3.9 Installing the RFID Reader (Start the Engine)



Pin Number	Color	Description
1	Red	Power output Output voltage: 5 V
2	Black	Ground wire
3	Green	Wiegand data 0
4	Yellow	Wiegand data 1
Remarks: The MVT600 RFID reader is not compatible with the T1 RFID reader. The T1 RFID reader is an RS232 port. For details about an RFID reader, see the <i>MEITRACK RFID User Guide</i> .		

## 8.4 Mounting the MVT600

Tighten the four screws shown in the following figure.





If you have any questions, do not hesitate to email us at [info@meitrack.com](mailto:info@meitrack.com).